

GEMÜ 205

Electrically operated solenoid valve

EN

Operating instructions



All rights including copyrights or industrial property rights are expressly reserved.

Keep the document for future reference.

© GEMÜ Gebr. Müller Apparatebau GmbH & Co. KG
07.12.2020

Contents

1	General information	4
1.1	Information	4
1.2	Symbols used	4
1.3	Definition of terms	4
1.4	Warning notes	4
2	Safety information	5
3	Product description	5
4	Correct use	6
5	Order data	7
6	Technical data	8
7	Dimensions	9
8	Manufacturer's information	12
8.1	Delivery	12
8.2	Transport	12
8.3	Storage	12
8.4	Scope of delivery	12
9	Installation in piping	12
10	Electrical connection	13
11	Commissioning	14
12	Operation	15
13	Inspection and maintenance	15
14	Troubleshooting	17
15	Removal from piping	18
16	Disposal	18
17	Returns	18
18	Declaration of Incorporation according to 2006/42/ EC (Machinery Directive)	19
19	Declaration of conformity according to 2014/30/EU (EMC Directive)	20
20	Declaration of conformity in accordance with 2014/35/EU (Low Voltage Directive) and 2014/30/EU (EMC Directive)	21
21	Declaration of conformity according to 2014/68/EU (Pressure Equipment Directive)	22

1 General information

1.1 Information

- The descriptions and instructions apply to the standard versions. For special versions not described in this document the basic information contained herein applies in combination with any additional special documentation.
- Correct installation, operation, maintenance and repair work ensure faultless operation of the product.
- Should there be any doubts or misunderstandings, the German version is the authoritative document.
- Contact us at the address on the last page for staff training information.

1.2 Symbols used

The following symbols are used in this document:

Symbol	Meaning
●	Tasks to be performed
▶	Response(s) to tasks
–	Lists

1.3 Definition of terms

Working medium

The medium that flows through the GEMÜ product.

1.4 Warning notes



Wherever possible, warning notes are organised according to the following scheme:

SIGNAL WORD	
Possible symbol for the specific danger	Type and source of the danger <ul style="list-style-type: none"> ▶ Possible consequences of non-observance. ● Measures for avoiding danger.

Warning notes are always marked with a signal word and sometimes also with a symbol for the specific danger.



The following signal words and danger levels are used:

 DANGER	
	Imminent danger! <ul style="list-style-type: none"> ▶ Non-observance can cause death or severe injury.
 WARNING	
	Potentially dangerous situation! <ul style="list-style-type: none"> ▶ Non-observance can cause death or severe injury.

 CAUTION	
	Potentially dangerous situation! <ul style="list-style-type: none"> ▶ Non-observance can cause moderate to light injury.

NOTICE	
	Potentially dangerous situation! <ul style="list-style-type: none"> ▶ Non-observance can cause damage to property.

The following symbols for the specific dangers can be used within a warning note:

Symbol	Meaning
	Danger of explosion
	Hot plant components!
	Risk of electric shock

2 Safety information

The safety information in this document refers only to an individual product. Potentially dangerous conditions can arise in combination with other plant components, which need to be considered on the basis of a risk analysis. The operator is responsible for the production of the risk analysis and for compliance with the resulting precautionary measures and regional safety regulations.

The document contains fundamental safety information that must be observed during commissioning, operation and maintenance. Non-compliance with these instructions may cause:

- Personal hazard due to electrical, mechanical and chemical effects.
- Hazard to nearby equipment.
- Failure of important functions.
- Hazard to the environment due to the leakage of dangerous materials.

The safety information does not take into account:

- Unexpected incidents and events, which may occur during installation, operation and maintenance.
- Local safety regulations which must be adhered to by the operator and by any additional installation personnel.

Prior to commissioning:

1. Transport and store the product correctly.
2. Do not paint the bolts and plastic parts of the product.
3. Carry out installation and commissioning using trained personnel.
4. Provide adequate training for installation and operating personnel.
5. Ensure that the contents of the document have been fully understood by the responsible personnel.
6. Define the areas of responsibility.
7. Observe the safety data sheets.
8. Observe the safety regulations for the media used.

During operation:

9. Keep this document available at the place of use.
10. Observe the safety information.
11. Operate the product in accordance with this document.
12. Operate the product in accordance with the specifications.
13. Maintain the product correctly.
14. Do not carry out any maintenance work and repairs not described in this document without consulting the manufacturer first.

In cases of uncertainty:

15. Consult the nearest GEMÜ sales office.

3 Product description

3.1 Construction



Item	Name	Materials
1	Plug	PA
2	Optical position indicator	PVC
3	Manual override	PBT
4	Valve housing	PBT
5	Valve body	PVC-U, grey or PVDF
	Seal materials	FPM, PTFE or EPDM

3.2 Description

The GEMÜ 205 directly controlled 2/2-way plastic solenoid valve has a high performance coil. It is hermetically separated from the medium by means of a flexible PTFE bush. The armature is sealed by a bellows made of PTFE backed by an additional safety diaphragm. The plug has a rectifier for use with an AC supply. A manual override and an optical position indicator are integrated as standard.

3.3 Function

The GEMÜ 205 servo assisted 2/2-way plastic solenoid valve is designed for controlling media.

When the valve is closed the medium flows into the valve body and presses onto the piston. The valve remains closed. Observe the permissible operating pressure (see "Technical data", page 8).

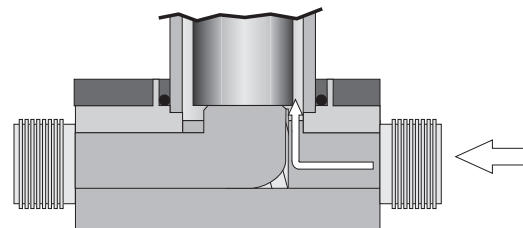

Fig. 1: Valve CLOSED

⚠ CAUTION

Operating pressure too high

- Damage to the solenoid / destruction of the solenoid.

NOTICE**Operating pressure too high**

- ▶ The valve cannot be opened electromagnetically if the operating pressure is too high.

When voltage is applied the solenoid in the valve actuator is activated and lifts the armature. This opens the valve outlet.

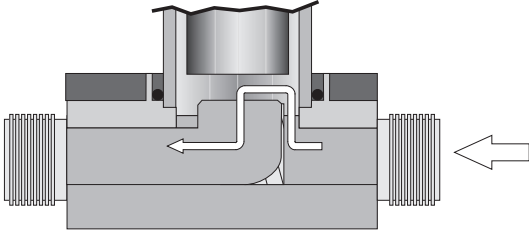

Fig. 2: Valve OPEN

4 Correct use**⚠ DANGER****Danger of explosion**

- ▶ Risk of severe injury or death.
- Only versions that have been approved according to their technical data may be used in potentially explosive environments.

⚠ WARNING**Improper use of the product**

- ▶ Risk of severe injury or death.
- ▶ Manufacturer liability and guarantee will be void.
- Only use the product in accordance with the operating conditions specified in the contract documentation and in this document.

The product is designed for installation in piping systems and for controlling a working medium.

1. Use the product in accordance with the technical data.
2. Protect the product from direct weathering.

5 Order data

The order data provide an overview of standard configurations.

Please check the availability before ordering. Other configurations available on request.

Order codes

1 Type	Code
Solenoid valve, directly controlled, optical position indicator, manual override	205

2 DN	Code
DN 10	10
DN 15	15
DN 20	20
DN 25	25
DN 32	32
DN 40	40
DN 50	50

3 Body configuration	Code
2/2-way body	D

4 Connection type	Code
Spigot DIN	0
Threaded socket DIN ISO 228	1
Solvent cement socket DIN	2
Union end with DIN insert (socket)	7
Spigot - inch	30

4 Continuation of Connection type	Code
Threaded socket NPT	31

5 Valve body material	Code
PVC-U, grey	1
PVDF	20

6 Seal material	Code
FPM	4
PTFE	5
EPDM	14

7 Control function	Code
Normally closed (NC)	1

8 Voltage	Code
24 V	24
120 V	120
230 V	230

9 Frequency	Code
DC	DC
50 - 60 Hz	50/60

Order example

Order option	Code	Description
1 Type	205	Solenoid valve, directly controlled, optical position indicator, manual override
2 DN	15	DN 15
3 Body configuration	D	2/2-way body
4 Connection type	0	Spigot DIN
5 Valve body material	1	PVC-U, grey
6 Seal material	5	PTFE
7 Control function	1	Normally closed (NC)
8 Voltage	230	230 V
9 Frequency	50/60	50 - 60 Hz

6 Technical data

6.1 Medium

Working medium: Corrosive, inert, gaseous and liquid media which have no negative impact on the physical and chemical properties of the body and seal material.

6.2 Temperature

Media temperature: PVC-U, grey (code 1): 10 to 60 °C
PVDF (code 20): -20 to 100 °C

Ambient temperature: 10 – 40 °C

Storage temperature: 0 – 40 °C

6.3 Product compliance

Machinery Directive: 2006/42/EC

Low Voltage Directive: 2014/35/EU

EMC Directive: 2014/30/EU
Technical standards used:
EN 55011:1991 (150 kHz to 30 MHz)
EN 55014:1993 (148.5 kHz to 30 MHz)

6.4 Mechanical data

Protection class: IP 65

Weight:

DN 10	DN 15	DN 20	DN 25	DN 32	DN 40	DN 50
0.85	0.9	0.9	2.8	2.8	3.6	3.6

Weights in kg

6.5 Pressure

Operating pressure:

DN 10	DN 15	DN 20	DN 25	DN 32*	DN 40	DN 50
0 - 6.0	0 - 2.0	0 - 1.0	0 - 1.0	0 - 1.0	0 - 0.2	0 - 0.2

* 24 V DC: 0 – 0.5 bar

All pressures are gauge pressures.

Nominal size corresponds to valve seat diameter.

Kv values:

DN 10	DN 15	DN 20	DN 25	DN 32	DN 40	DN 50
0.8	1.8	2.3	6.0	7.5	9.5	12.5

Kv values in m³/h

6.6 Electrical data

Power consumption:

AC operation		
Pull in	DN 10 - 20	125 VA
	DN 25 - 50	400 VA
Hold in	DN 10 - 20	12 VA
	DN 25 - 50	30 VA
DC operation		
Pull in	DN 10 - 20	35 W
	DN 25 - 50	70 W
Hold in	DN 10 - 20	7 W
	DN 25 - 50	18 W

Permissible voltage tolerance: ±10 % to VDE 0580

Duty cycle: Continuous duty

Wiring note: Special wiring on request. When using electronic switches and additional wiring, carefully design out any potential residual currents upon installation.

Installation note: Please note: The DC solenoid is designed for unsmoothed voltages, e.g. as obtained from a bridge rectifier.

7 Dimensions

7.1 Actuator

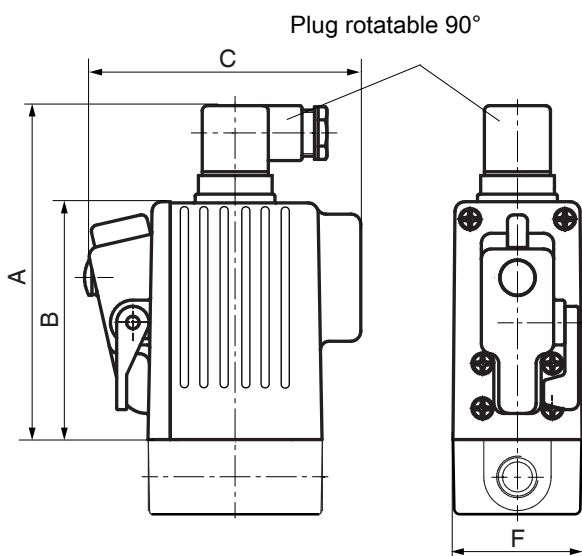

	DN 10	DN 15	DN 20	DN 25	DN 32	DN 40	DN 50
A	134	134	134	167	167	196	196
B	100	100	100	128	128	157	157
C	110	110	110	144	144	158	158
F	52	52	52	88	88	110	110

Dimensions in mm

7.2 Body dimensions

7.2.1 Solvent cement spigot (code 0, 30)

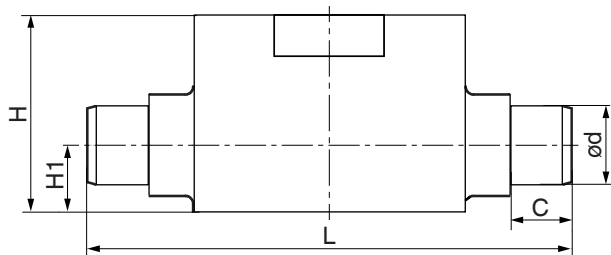

	Connection Code ¹⁾	DN 15	DN 20	DN 25	DN 32	DN 40	DN 50
C		16	19	22	26	31	39
ød	0	20	25	32	40	50	63
	30	21.3	26.7	33.4	-	-	-
H		50	50	72	72	85	85
H1		17	17	24	24	34	34
L		124	144	154	174	194	224

Dimensions in mm

1) Connection type

Code 0: Spigot DIN

Code 30: Spigot - inch

7.2.2 Threaded socket (code 1, 31)

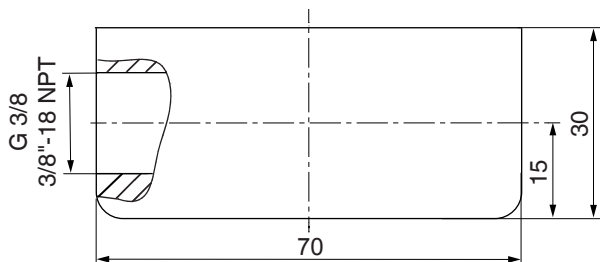

Dimensions in mm

7.2.3 Solvent cement socket (code 2)

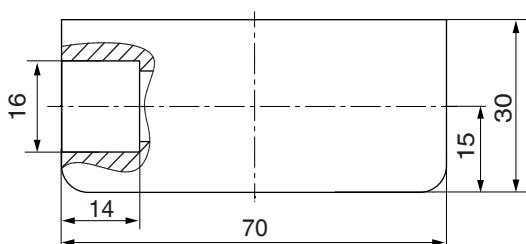

Dimensions in mm

7.2.4 Union end with insert (code 7)

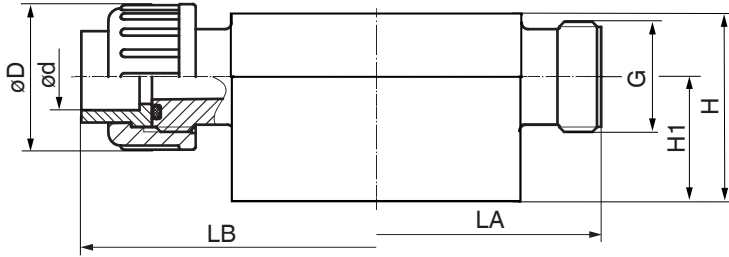

	Material Code ¹⁾	DN 10	DN 15	DN 20
$\varnothing d$		16	20	25
$\varnothing d$		G 3/4	G 1	G 1 1/4
H		45	63	63
H1		30	30	30
$\varnothing D$	1	35	43	53
LA		108	108	108
LB		142	146	152
$\varnothing D$	20	34	47	57
LA		106	106	106
LB		142	144	148

Dimensions in mm

1) Valve body material

Code 1: PVC-U, grey

Code 20: PVDF

7.3 Mounting dimensions

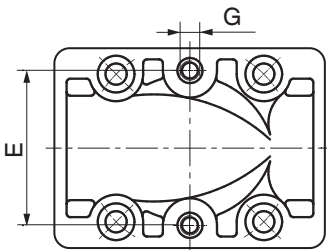

	Connection Code ¹⁾	DN 10	DN 15	DN 20	DN 25	DN 32	DN 40	DN 50
E		40	40	40	44.5	44.5	44.5	44.5
G	0,1,2,7	M5	M5	M5	M8	M8	M8	M8
	30,31	8 - 36 UNF	10 - 32 UNF	10 - 32 UNF	5/16" - 32 UNF	-	-	-

Dimensions in mm

1) Connection type

Code 0: Spigot DIN

Code 1: Threaded socket DIN ISO 228

Code 2: Solvent cement socket DIN

Code 7: Union end with DIN insert (socket)

Code 30: Spigot - inch

Code 31: Threaded socket NPT

8 Manufacturer's information

8.1 Delivery

- Check that all parts are present and check for any damage immediately upon receipt.

The product's performance is tested at the factory. The scope of delivery is apparent from the dispatch documents and the design from the order number.

8.2 Transport

1. Only transport the product by suitable means. Do not drop. Handle carefully.
2. After the installation dispose of transport packaging material according to relevant local or national disposal regulations / environmental protection laws.

8.3 Storage

1. Store the product free from dust and moisture in its original packaging.
2. Avoid UV rays and direct sunlight.
3. Do not exceed the maximum storage temperature (see chapter "Technical data").
4. Do not store solvents, chemicals, acids, fuels or similar fluids in the same room as GEMÜ products and their spare parts.

8.4 Scope of delivery

The following is included in the scope of delivery:

- Solenoid valve with solenoid coil
- Plug
- Installation, operating and maintenance instructions

9 Installation in piping

⚠ WARNING

The equipment is subject to pressure!

- ▶ Risk of severe injury or death.
- Depressurize the plant.
- Completely drain the plant.

⚠ CAUTION



Hot plant components!

- ▶ Risk of burns.
- Only work on plant that has cooled down.

⚠ CAUTION

Operating pressure too high or working medium temperature too high

- ▶ Damage to the valve body
- Only install the solenoid valve in aligned pipes in order to avoid stresses in the valve body.
- Do not exceed the permissible operating pressure.
- Do not exceed the permissible temperature of the working medium.

9.1 Installation with solvent cement sockets

⚠ CAUTION

Wrong solvent cement

- ▶ Valve body will be damaged.
- Only use solvent cement suitable for the valve body.

NOTICE

- ▶ The solvent cement is not included in the scope of delivery.
- Only use suitable solvent cement!

1. Apply solvent cement inside the valve body socket connections and on the piping as specified by the solvent cement manufacturer.
2. Solvent cement the valve body to the piping.

9.2 Installation with solvent cement spigots

⚠ CAUTION

Wrong solvent cement

- ▶ Valve body will be damaged.
- Only use solvent cement suitable for the valve body.

NOTICE

- ▶ The solvent cement is not included in the scope of delivery.
- Only use suitable solvent cement!

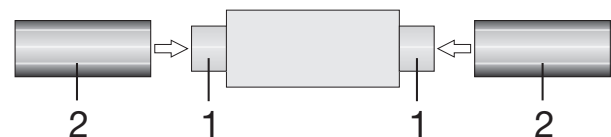

1. Apply solvent cement on the outside of the valve body spigots **1** and on the inside of the piping connector **2** as specified by the solvent cement manufacturer.
2. Connect the valve body to the piping.

9.3 Installation with threaded sockets

NOTICE

Thread sealant

- ▶ The thread sealant is not included in the scope of delivery.
- Only use appropriate thread sealant.

- Screw the threaded connections into the piping in accordance with valid standards.

9.4 Installation with union ends

⚠ CAUTION

Do not use the solenoid coil as a lever

- ▶ If the solenoid coil is used as a lever, the solenoid coil and bush could be destroyed.
- Use only the spanner flats provided to screw the solenoid valve to the piping.

⚠ CAUTION

Welding!

- ▶ Damage to the valve actuator or valve body.
- Observe welding standards.

⚠ CAUTION

Wrong solvent cement

- ▶ Valve body will be damaged.
- Only use solvent cement suitable for the valve body.

NOTICE

- ▶ The solvent cement is not included in the scope of delivery.
- Only use suitable solvent cement!

1. Push the union nut **1** over the piping **4**. Connect the insert **5** with the piping **4** by cementing / welding.

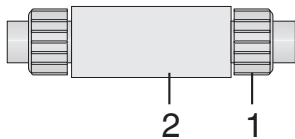

2. Unscrew union nut **1** from valve body **2**.

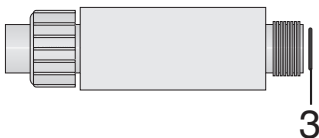

3. Reinsert O-ring **3** if necessary.
4. Screw the union nut **1** to the valve body **2** again.
5. Connect the other side of the valve body **2** to the piping **4**, too.

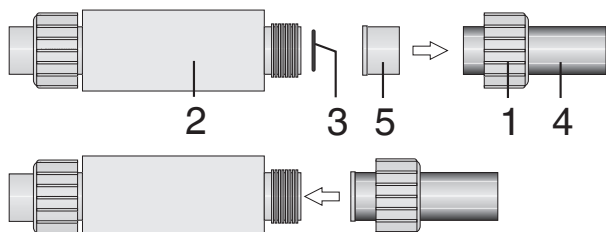

10 Electrical connection

⚠ DANGER



Risk of electric shock

- ▶ Risk of injury or death (if operating voltage is higher than safe extra low voltage).
- ▶ Electric shock can cause severe burns and fatal injury.
- Work on electrical connections only by qualified trained personnel.
- Disconnect the cable from the power supply before making the electrical connection.
- Connect the protective earth conductor.

⚠ CAUTION

AC voltage

- ▶ Solenoid valve will be destroyed by wrong plug.
- Solenoid valves used with AC voltage may only be operated with a plug with a built-in rectifier (only up to DN20).

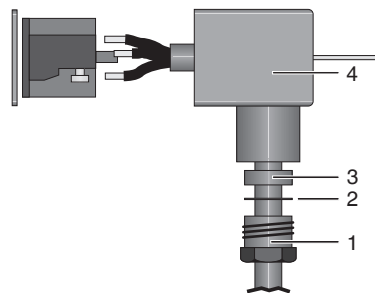

1. Insert the cable through the locking screw **1**, the pressure ring **2**, the seal **3** and the housing of the plug **4**.

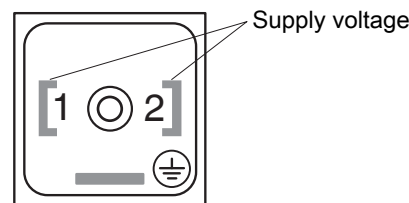

Item	Name
1	Supply voltage
2	Supply voltage
⊕	Protective earth conductor (PE)

2. Connect the cable to the relevant terminals on the terminal block.
3. Push the terminal block into the housing of the plug (acc. to DIN EN 175301-803, previously DIN 43650) until it audibly clicks in position.
4. Ensure that the cable is not caught.
5. Tighten the locking screw on the plug.

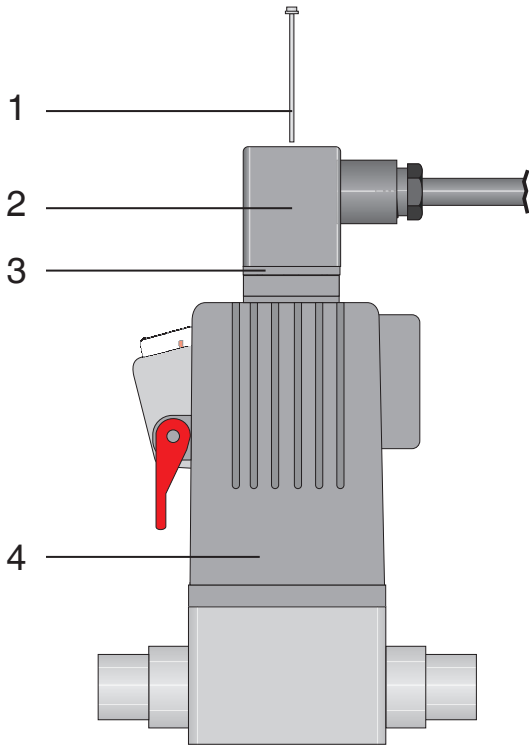

6. Push the plug 2 and the gasket 3 onto the valve actuator 4.
7. Tighten the fixing screw 1 with a torque of approx. 0.6 Nm.

NOTICE

▶ If the torque is too high the thread may be stripped.

11 Commissioning

CAUTION

Medium flowing out

- ▶ Danger from medium flowing out.
- Before commissioning make sure that there is no danger from medium flowing out.
- Before commissioning check the tightness of the media connections.

NOTICE

Operating pressure too high

- ▶ The valve cannot be opened electromagnetically if the operating pressure is too high.

CAUTION

Foreign matter

- ▶ Damage to the valves.
- If the plant is new and after repairs, rinse the piping system with the valves fully open.
- ⇒ The plant operator is responsible for selecting the cleaning material and performing the procedure.

1. Make sure that the operating voltage corresponds with the permissible valve voltage.
2. Make sure that the unit is installed properly.
3. Check the function of the solenoid valve.
4. Check the tightness of the media connections and the solenoid valve itself.

11.1 Optical position indicator

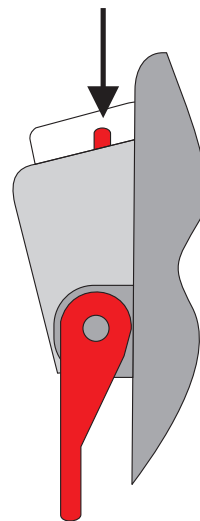

Valve closed

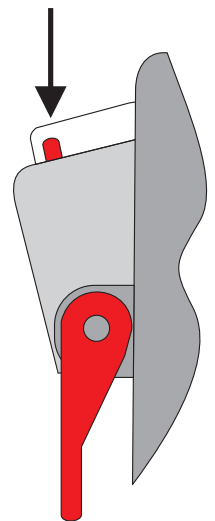

Valve open

12 Operation

12.1 Normal operation

During normal operation there is no need for adjustments at the valve.

12.2 Emergency operation via manual override

NOTICE

Manual override

- ▶ Only actuate the manual override in case of malfunction (currentless)!

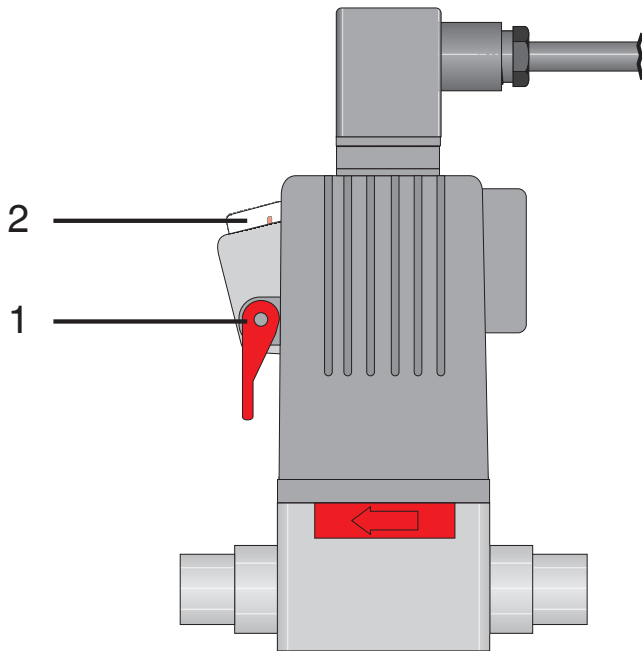

The solenoid valve is equipped with a manual override 1 and an optical position indicator 2.

Open the valve via manual override (currentless)

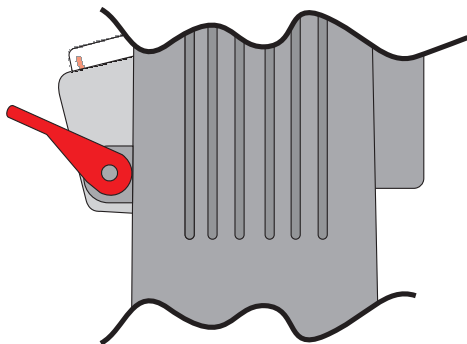

1. Turn the lever upwards.
- ⇒ The indicator of the optical position indicator moves away from the valve actuator.

Close the valve via manual override (currentless)

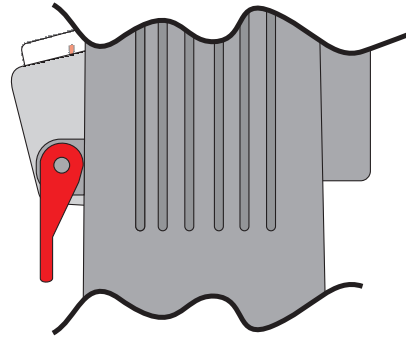

2. Turn the lever downwards.
- ⇒ The indicator of the optical position indicator moves towards the valve actuator.

13 Inspection and maintenance

⚠ WARNING

The equipment is subject to pressure!

- ▶ Risk of severe injury or death.
- Depressurize the plant.
- Completely drain the plant.

⚠ CAUTION

Use of incorrect spare parts!

- ▶ Damage to the GEMÜ product.
- ▶ Manufacturer liability and guarantee will be void.
- Use only genuine parts from GEMÜ.

⚠ CAUTION



Hot plant components!

- ▶ Risk of burns.
- Only work on plant that has cooled down.

NOTICE

Exceptional maintenance work!

- ▶ Damage to the GEMÜ product.
- Any maintenance work and repairs not described in these operating instructions must not be performed without consulting the manufacturer first.

The operator must carry out regular visual examination of the GEMÜ products depending on the operating conditions and the potential danger in order to prevent leakage and damage.

The product also must be disassembled and checked for wear in the corresponding intervals.

1. Have servicing and maintenance work performed by trained personnel.
2. Wear appropriate protective gear as specified in plant operator's guidelines.
3. Shut off plant or plant component.
4. Secure plant or plant component against recommissioning.
5. Depressurize the plant or plant component.
6. Actuate GEMÜ products which are always in the same position four times a year.

13.1 Cleaning the product

⚠ CAUTION

Foreign matter

- ▶ Damage to the valves.
- If the plant is new and after repairs, rinse the piping system with the valves fully open.
- ⇒ The plant operator is responsible for selecting the cleaning material and performing the procedure.

- Clean the product with a damp cloth.
- Do **not** clean the product with a high pressure cleaning device.

13.2 Spare parts

Spare parts	
Plugs	GEMÜ 1220
	GEMÜ 1221

Order number on request

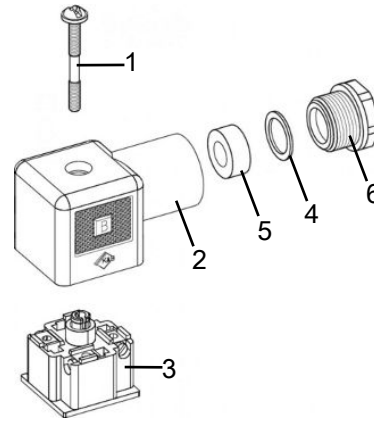



Item	Name
1	Screw
2	Plug
3	Terminal block
4	Pressure ring
5	Gasket
6	Cable entry

14 Troubleshooting

Error	Error cause	Troubleshooting
No function	No power supply	Check power supply and connection with product label
	Solenoid coil faulty	Replace solenoid valve
	Plug wrongly connected	Check connection of plug and correct if necessary
	Operating pressure too high	Check operating pressure, reduce if necessary
	PTFE bush leaking	Replace solenoid valve
	Armature blocked	Replace solenoid valve
Solenoid valve leaking	Valve seat leaking	Replace solenoid valve
Solenoid valve does not close	Manual override engaged/actuated	Check the position of the manual override and close if necessary

15 Removal from piping

 WARNING	
The equipment is subject to pressure!	
<ul style="list-style-type: none">▶ Risk of severe injury or death.● Depressurize the plant.● Completely drain the plant.	

 CAUTION	
	Hot plant components!
	<ul style="list-style-type: none">▶ Risk of burns.● Only work on plant that has cooled down.

1. Allow the plant to cool down.
2. Allow the plant to run empty.
3. Unscrew the electrical wiring.
4. Remove the product from the piping with appropriate measures

16 Disposal

1. Pay attention to adhered residual material and gas diffusion from penetrated media.
2. Dispose of all parts in accordance with the disposal regulations/environmental protection laws.

17 Returns

Legal regulations for the protection of the environment and personnel require that the completed and signed return delivery note is included with the dispatch documents. Returned goods can be processed only when this note is completed. If no return delivery note is included with the product, GEMÜ cannot process credits or repair work but will dispose of the goods at the operator's expense.

1. Clean the product.
2. Request a return delivery note from GEMÜ.
3. Complete the return delivery note.
4. Send the product with a completed return delivery note to GEMÜ.

18 Declaration of Incorporation according to 2006/42/EC (Machinery Directive)

Declaration of Incorporation
according to the EC Machinery Directive 2006/42/EC, Annex II, 1.B for partly
completed machinery

We, GEMÜ Gebr. Müller Apparatebau GmbH & Co. KG
Fritz-Müller-Straße 6-8
74653 Ingelfingen-Criesbach, Germany

declare that the following product

Make: GEMÜ
Serial number: from 29.12.2009
Project number: Type 205
Commercial name: GEMÜ 205

meets the following essential requirements of the Machinery Directive 2006/42/EC:

1.1.5., 1.2.1., 1.3., 1.3.2., 1.3.9., 1.5.1., 1.5.2., 1.5.5., 1.5.6., 1.5.7., 1.5.16., 1.6.3.

We also declare that the specific technical documentation has been compiled in accordance with part B of Annex VII.

The manufacturer or his authorised representative undertake to transmit, in response to a reasoned request by the national authorities, relevant information on the partly completed machinery. This transmission takes place:

Electronically

Authorised documentation officer **GEMÜ Gebr. Müller Apparatebau GmbH & Co. KG**
Fritz-Müller-Straße 6-8
74653 Ingelfingen, Germany

This does not affect the industrial property rights!

Important note! The partly completed machinery may be put into service only if it was determined, where appropriate, that the machinery into which the partly completed machinery is to be installed meets the provisions of this Directive.

2018-03-28



Joachim Brien
Head of Technical Department

19 Declaration of conformity according to 2014/30/EU (EMC Directive)

EU Declaration of Conformity
in accordance with 2014/30/EU (EMC Directive)

We, GEMÜ Gebr. Müller Apparatebau GmbH & Co. KG
Fritz-Müller-Straße 6-8
74653 Ingelfingen-Criesbach, Germany

declare that the product listed below complies with the safety requirements of the EMC Directive 2014/30/EU.

Description of the product: GEMÜ 205

Technical standards used:

Interference emission:

2020-09-23



Joachim Brien
Head of Technical Department

20 Declaration of conformity in accordance with 2014/35/EU (Low Voltage Directive) and 2014/30/EU (EMC Directive)

EU Declaration of Conformity

Texts

2020-09-23

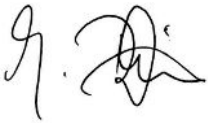

Joachim Brien
Head of Technical Department

2020-09-23



Joachim Brien
Head of Technical Department

21 Declaration of conformity according to 2014/68/EU (Pressure Equipment Directive)

EU Declaration of Conformity

in accordance with 2014/68/EU (Pressure Equipment Directive)

We, GEMÜ Gebr. Müller Apparatebau GmbH & Co. KG
Fritz-Müller-Straße 6-8
74653 Ingelfingen-Criesbach, Germany

declare that the product listed below complies with the safety requirements of the Pressure Equipment Directive 2014/68/EU.

Description of the pressure equipment: GEMÜ P600
Notified body: TÜV Rheinland
Berlin Brandenburg
Number: 0035
Certificate no.: 01 202 926/Q-02 0036
Conformity assessment procedure: Module H
Technical standard used: AD 2000

Note for products with a nominal size \leq DN 25:

The products are developed and produced according to GEMÜ process instructions and quality standards which comply with the requirements of ISO 9001 and ISO 14001.

According to Article 4, Paragraph 3 of the Pressure Equipment Directive 2014/68/EU these products must not be identified by a CE-label.

2020-09-23



Joachim Brien
Head of Technical Department



GEMÜ Gebr. Müller Apparatebau GmbH & Co. KG
Fritz-Müller-Straße 6-8, 74653 Ingelfingen-Criesbach, Germany
Phone +49 (0) 7940 1230 · info@gemue.de
www.gemu-group.com

Subject to alteration

12.2020 | 88593456

